

ULTRADESK®

Frag

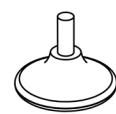

N*4

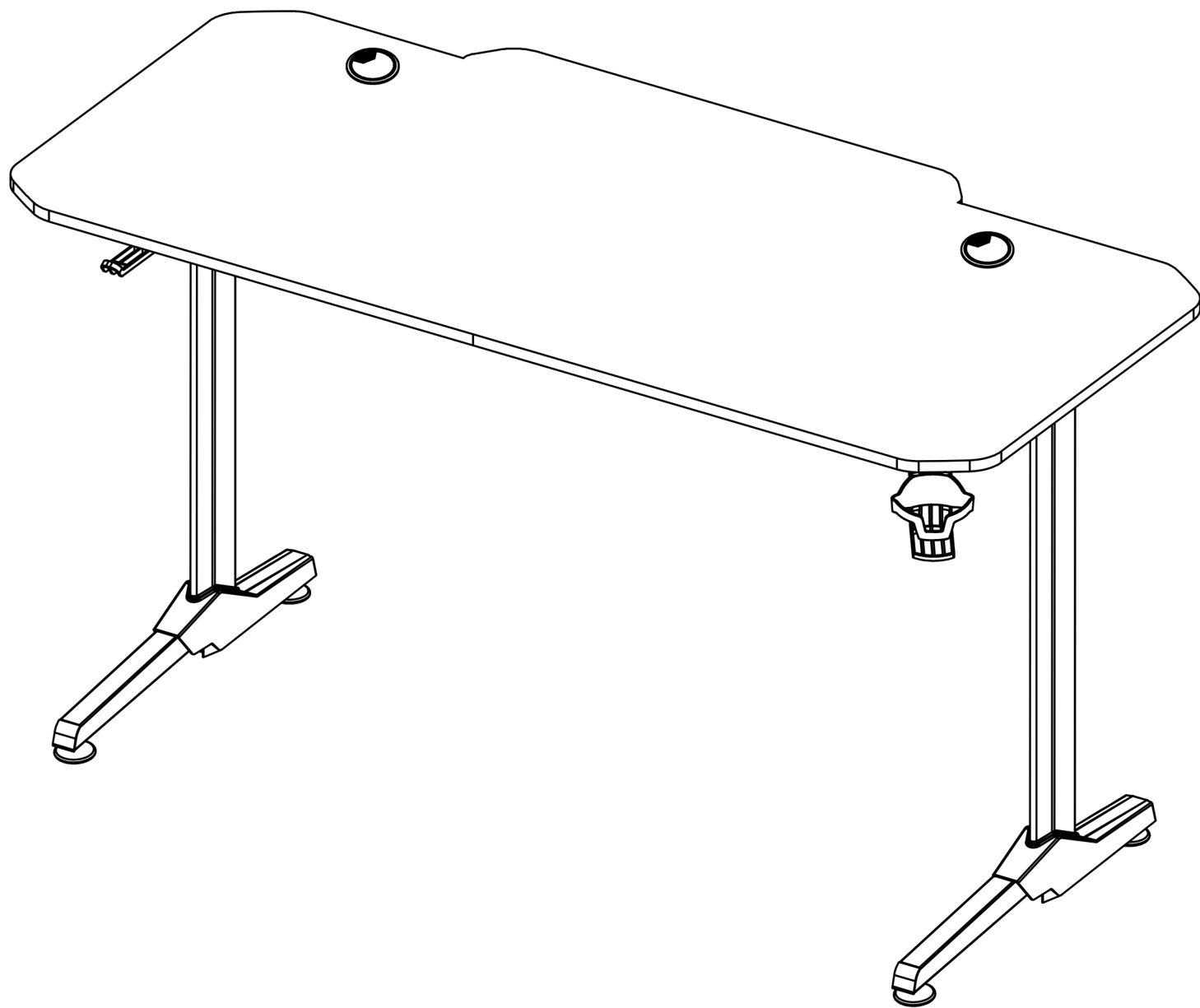
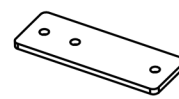

O*1



P*2



M10*20
S1*6



M8*16
S2*10

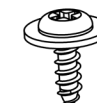

M4*14
S3*36



6mm
R*1

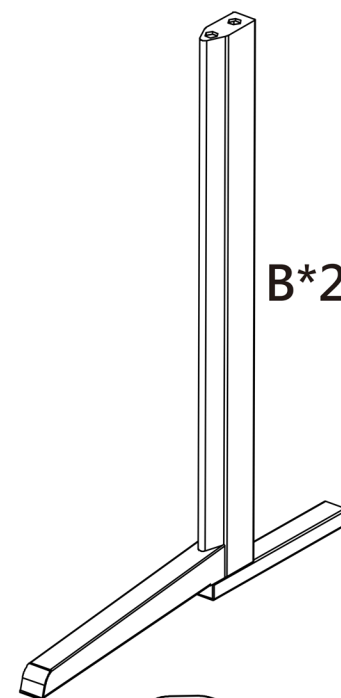

B*2

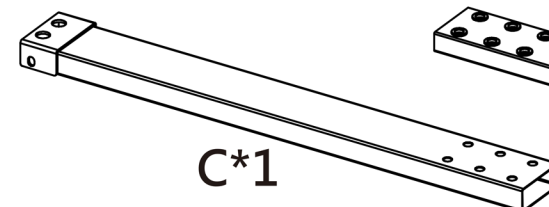

C*1

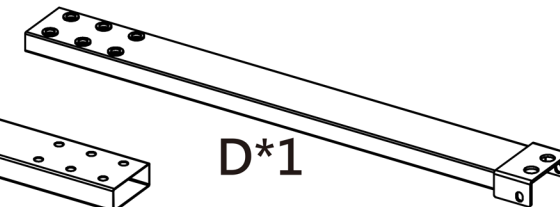

D*1

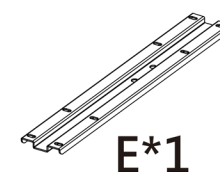

E*1

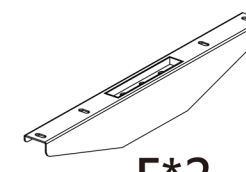

F*2

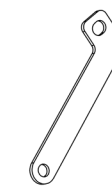

T*2



G*1

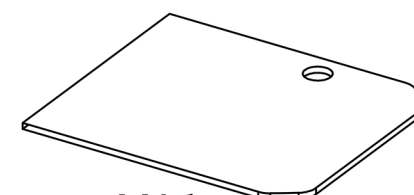

H*1



I*1

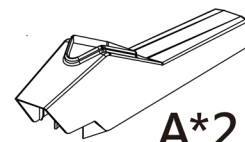

A*2

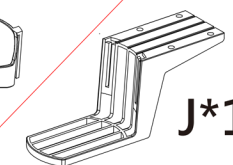

J*1

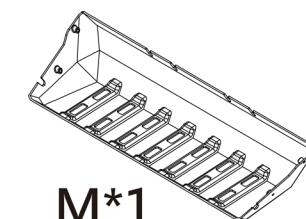

M*1

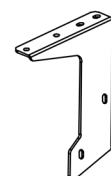

L1



L2

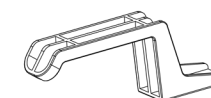

K*1

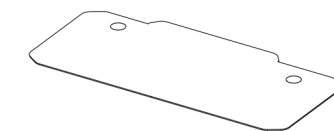

Q*1

